

**WAGO → I/O → SYSTEM 750**

## **Fieldbus Independent I/O Modules**

**2 AI 4-20 mA, Single-Ended  
750-466(/xxx-xxx)**



## **Manual**

Version 1.0.5

Copyright © 2008 by WAGO Kontakttechnik GmbH & Co. KG  
All rights reserved.

**WAGO Kontakttechnik GmbH & Co. KG**

Hansastraße 27  
D-32423 Minden

Phone: +49 (0) 571/8 87 – 0

Fax: +49 (0) 571/8 87 – 1 69

E-Mail: [info@wago.com](mailto:info@wago.com)

Web: <http://www.wago.com>

**Technical Support**

Phone: +49 (0) 571/8 87 – 5 55

Fax: +49 (0) 571/8 87 – 85 55

E-Mail: [support@wago.com](mailto:support@wago.com)

Every conceivable measure has been taken to ensure the correctness and completeness of this documentation. However, as errors can never be fully excluded, we would appreciate any information or ideas at any time.

E-Mail: [documentation@wago.com](mailto:documentation@wago.com)

We wish to point out that the software and hardware terms as well as the trademarks of companies used and/or mentioned in the present manual are generally trademark or patent protected.

---

# Content

<b>1 Important Comments .....</b>	<b>4</b>
1.1 Legal Principles .....	4
1.1.1 Copyright .....	4
1.1.2 Personnel Qualification .....	4
1.1.3 Intended Use .....	4
1.2 Symbols .....	5
1.3 Number Notation .....	5
1.4 Safety Notes .....	6
1.5 Scope .....	4
<b>2 I/O Modules .....</b>	<b>7</b>
2.1 Digital Input Modules .....	7
2.1.1 750-466(/xxx-xxx) [2 AI 4-20 mA, Single-Ended] .....	7
2.1.1.1 Variations .....	7
2.1.1.2 View .....	7
2.1.1.3 Description .....	8
2.1.1.4 Display Elements .....	9
2.1.1.5 Schematic Diagram .....	9
2.1.1.6 Technical Data .....	10
2.1.1.7 Process Image .....	11
2.1.1.7.1 Standard Data Format .....	12
2.1.1.7.2 Special Data Format .....	13

# 1 Important Comments

To ensure fast installation and start-up of the units described in this manual, we strongly recommend that the following information and explanations are carefully read and abided by.

## 1.1 Legal Principles

### 1.1.1 Copyright

This manual is copyrighted, together with all figures and illustrations contained therein. Any use of this manual which infringes the copyright provisions stipulated herein, is not permitted. Reproduction, translation and electronic and photo-technical archiving and amendments require the written consent of WAGO Kontakttechnik GmbH & Co. KG. Non-observance will entail the right of claims for damages.

WAGO Kontakttechnik GmbH & Co. KG reserves the right to perform modifications allowed by technical progress. In case of grant of a patent or legal protection of utility patents all rights are reserved by WAGO Kontakttechnik GmbH & Co. KG. Products of other manufacturers are always named without referring to patent rights. The existence of such rights can therefore not be ruled out.

### 1.1.2 Personnel Qualification

The use of the product detailed in this manual is exclusively geared to specialists having qualifications in PLC programming, electrical specialists or persons instructed by electrical specialists who are also familiar with the valid standards. WAGO Kontakttechnik GmbH & Co. KG declines all liability resulting from improper action and damage to WAGO products and third party products due to non-observance of the information contained in this manual.

### 1.1.3 Intended Use

For each individual application, the components supplied are to work with a dedicated hardware and software configuration. Modifications are only permitted within the framework of the possibilities documented in the manuals. All other changes to the hardware and/or software and the non-conforming use of the components entail the exclusion of liability on part of WAGO Kontakttechnik GmbH & Co. KG.

Please direct any requirements pertaining to a modified and/or new hardware or software configuration directly to WAGO Kontakttechnik GmbH & Co. KG.

## 1.2 Symbols



### **Danger**

Always abide by this information to protect persons from injury.



### **Warning**

Always abide by this information to prevent damage to the device.



### **Attention**

Marginal conditions must always be observed to ensure smooth operation.



### **ESD (Electrostatic Discharge)**

Warning of damage to the components by electrostatic discharge. Observe the precautionary measure for handling components at risk.



### **Note**

Routines or advice for efficient use of the device and software optimization.



### **Additional Information**

References on additional literature, manuals, data sheets and internet pages.

## 1.3 Number Notation

Number Code	Example	Note
Decimal	100	normal notation
Hexadecimal	0x64	C notation
Binary	'100' '0110.0100'	within inverted commas, nibble separated with dots

## 1.4 Safety Notes



---

### Warning

Switch off the system prior to working on bus modules!

In the event of deformed contacts, the module in question is to be replaced, as its functionality can no longer be ensured on a long-term basis.

The components are not resistant against materials having seeping and insulating properties. Belonging to this group of materials is: e.g. aerosols, silicones, triglycerides (found in some hand creams).

If it cannot be ruled out that these materials appear in the component environment, then additional measures are to be taken:

- installation of the components into an appropriate enclosure
  - handling of the components only with clean tools and materials.
- 



---

### Attention

Cleaning of soiled contacts may only be done with ethyl alcohol and leather cloths. Thereby, the ESD information is to be regarded.

Do not use any contact spray. The spray may impair the functioning of the contact area.

The WAGO-I/O-SYSTEM 750 and its components are an open system. It must only be assembled in housings, cabinets or in electrical operation rooms. Access must only be given via a key or tool to authorized qualified personnel.

The relevant valid and applicable standards and guidelines concerning the installation of switch boxes are to be observed.

---



---

### ESD (Electrostatic Discharge)

The modules are equipped with electronic components that may be destroyed by electrostatic discharge. When handling the modules, ensure that the environment (persons, workplace and packing) is well grounded. Avoid touching conductive components, e.g. gold contacts.

---

## 1.5 Scope

This manual describes the Analog Input Module 750-466(/xxx-xxx)  
2 AI 4-20 mA, Single-Ended of the modular WAGO-I/O-SYSTEM 750.

Handling, assembly and start-up are described in the manual of the Fieldbus Coupler. Therefore this documentation is valid only in the connection with the appropriate manual.

## 2 I/O Modules

### 2.1 Digital Input Modules

#### 2.1.1 750-466(/xxx-xxx) [2 AI 4-20 mA, Single-Ended]

2-Channel Analog Input Module (4-20 mA, Single-Ended)

##### 2.1.1.1 Variations

Item-No.	Designation	Description
750-466	2 AI (4-20mA) Single-Ended	2-Channel Analog Input Module, 4-20mA, Single-Ended
750-466/000-001	2 AI (4-20mA) Single-Ended, RC low pass 5 Hz	2-Channel Analog Input Module, 4-20mA, Single-Ended with RC low-pass ( $P_{T2} / f_{3dB} = 5 \text{ Hz}$ )
750-466/000-002	2 AI (4-20mA) Single-Ended, special data format	2-Channel Analog Input Module, 4-20mA, Single-Ended with special data format
750-466/000-200	2 AI (4-20mA) Single-Ended with Siemens (S5-FB 250)	2-Channel Analog Input Module, 4-20mA, Single-Ended, adapted data format for S5-control systems with the use of function block FB 250
750-466/025-000	2 AI 4-20 mA/T	2-Channel Analog Input Module (4-20 mA, Single-Ended) extended temperature range from $-20 \text{ }^{\circ}\text{C}$ to $+60 \text{ }^{\circ}\text{C}$

##### 2.1.1.2 View

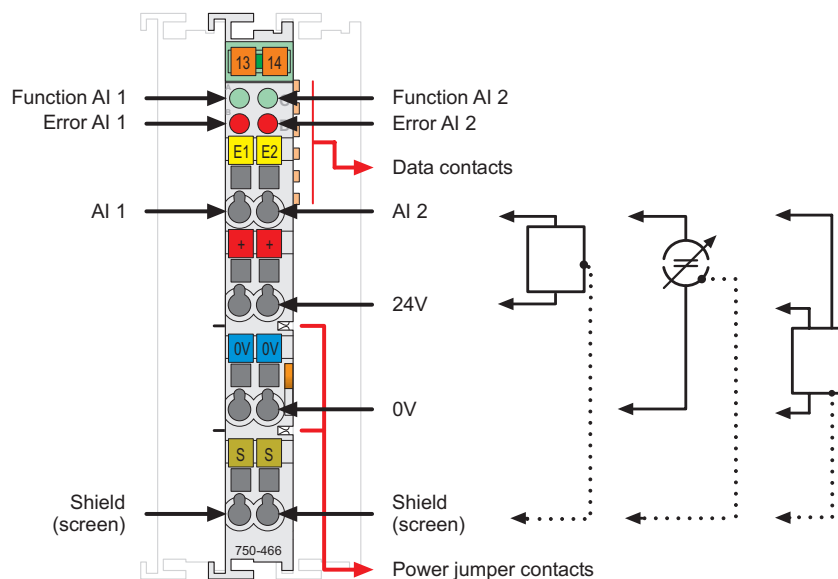

Fig. 2.1.1-1: View

g046600e

### 2.1.1.3 Description

The analog input module and its variations receives signals with standardized values of 0-20 mA.

2- or 3- conductor transducers can be connected, which do not possess an own voltage supply, e.g. adjustable resistor, pressure gauge, etc. These transducers are supplied with 24 V directly from the module.

The module has two input channels. The fieldside signals may be received via the connections AI 1 or AI 2.

Two-conductor transducers are supplied via 24 V connections and 3-conductor transducers via 24 V and 0 V connections.

The input channels of a module have a common ground and a shield (screen) connection (S). The Shield (screen) is directly connected to the DIN rail. A capacitive connection is made automatically when snapped onto the DIN rail.

The input signal of each channel is electrically isolated and will be transmitted with a resolution of 12 bits.

The operational readiness and trouble-free internal data bus communication of the channels are indicated via a green Function LED. Broken wire, overrange or underflow of the measuring range is indicated via a red error LED.

Any configuration of the input modules is possible when designing the fieldbus node. Grouping of module types is not necessary.

The field side supply voltage of 24 V and 0 V for the input module is derived from adjacent I/O modules or from a supply module. The supply voltage for the field side is made automatically through the individual I/O modules by means of power jumper contacts.



---

#### Warning

The maximum current of the internal power jumper contacts is 10 A. When configuring the system it is important not to exceed the maximum/sum current. However, if such a case should occur, another supply module must be added.

---

The analog input module 750-466 and its variations can be used with all couplers/controllers of the WAGO-I/O-SYSTEM 750 (except for the economy types 750-320, -323, -324 and -327).



2.1.1.4 Display Elements

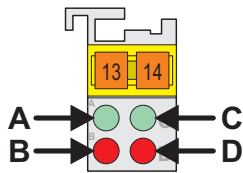

Fig. 2.1.1-2: Display Elements g041802x

LED	Channel	Meaning	State	Function
A	1	Function AI 1	off	No operational readiness or the internal data bus communication is interrupted
			green	Operational readiness and trouble-free internal data bus communication
B		Error AI 1	off	Normal operation
			red	Broken wire, overrange/underflow of the admissible measuring range
C	2	Function AI 2	off	No operational readiness or the internal data bus communication is interrupted
			green	Operational readiness and trouble-free internal data bus communication
D		Error AI 2	off	Normal operation
			red	Broken wire, overrange/underflow of the admissible measuring range

2.1.1.5 Schematic Diagram

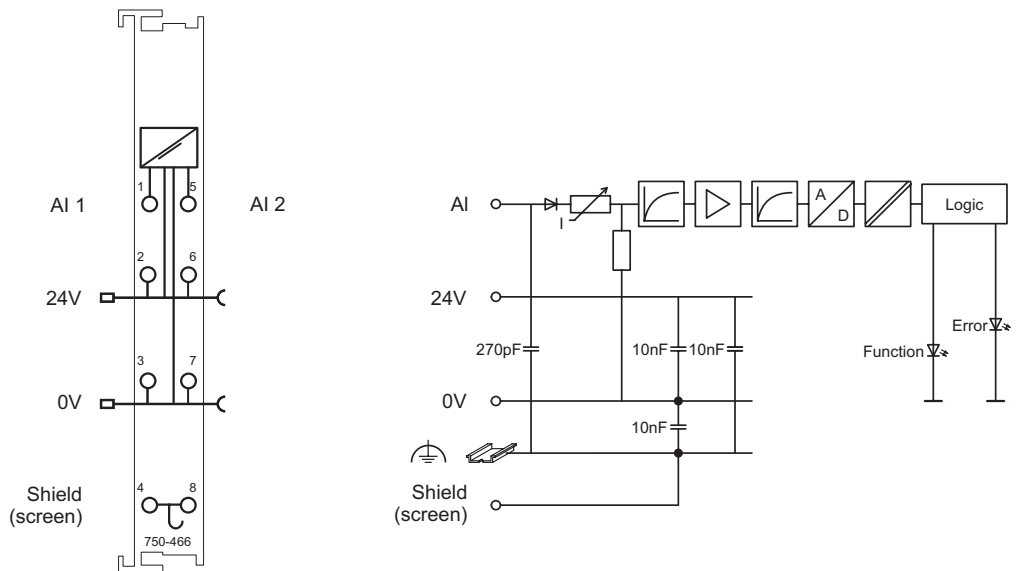





Fig. 2.1.1-3: Schematic Diagram

g046601e

2.1.1.6 Technical Data

Module Specific Data		
Number of inputs	2	
Voltage supply	via system voltage DC /DC	
Current consumption <sub>typ.</sub> (internal)	75 mA	
Input voltage <sub>max.</sub>	10 V	
Signal current	4 mA ... 20 mA	
Conversion time <sub>typ.</sub>	<220 Ω at 20 mA	
Resolution	12 bits	
Conversion time <sub>typ.</sub>	2 ms	
Measuring error <sub>25°C</sub>	<± 0.2 % of full scale value	
Temperature coefficient	<± 0.01 % /K of full scale value	
Isolation	500 V (Field/System)	
Bit width	2 x 16 bits data 2 x 8 bits control/status (option)	
Dimensions (mm) W x H x L	12 x 64* x 100 * from upper edge of 35 DIN rail	
Weight	ca. 55 g	
Standards and Regulations (cf. Chapter 2.2 of the Coupler/Controller Manual)		
EMC-Immunity to interference (CE)	acc. to EN 50082-2 (96)	
EMC-Emission of interference (CE)	acc. to EN 50081-1 (93)	
Approvals (cf. Chapter 2.2 of the Coupler/Controller Manual)		
	cUL <sub>US</sub> (UL508)	
	cUL <sub>US</sub> (ANSI/ISA 12.12.01)	Class I Div2 ABCD T4
	DEMKO / IEC	I M2 / II 3 G/D Ex nA IIC T4
	Conformity Marking	



**More Information**

Detailed references to the approvals are listed in the document "Overview Approvals WAGO-I/O-SYSTEM 750", which you can find on the CD ROM ELECTRONICC Tools and Docs (Item-No.: 0888-0412)

or in the internet under:

[www.wago.com](http://www.wago.com) → Documentation → WAGO-I/O-SYSTEM 750 → System Description

### 2.1.1.7 Process Image

The analog input module 750-466 and its variations transmit 16-bit measured values and 8 status bits per channel.

The digitalized measured value is transmitted in a data word (16 bits) as input byte 0 (low) and input byte 1 (high) into the process image of the coupler / controller.

This value is represented with a 12 bit resolution on bit B3 ... B14.

From the manufacturing number |32|02|XX|XX| onwards, the status information included in the three least significant bits (B0 ... B2) can be parsed in the event of an error

Bit B0 = 1 is set when the range of measurement is overranged.

Bit B0 and B1 = 1 are set in case of measurement range underflow or broken wire. For modules having a previous manufacturing number, the last 3 bits are not parsed.

The manufacturing number is part of the lateral marking on the module enclosure.

Some fieldbus systems can process input channel status information by means of a status byte.

This status byte can be displayed via the starting tool WAGO-I/O-CHECK 2. However, processing via the coupler / controller is optional, which means that accessing or parsing the status information depends on the fieldbus system.



---

#### Attention

The representation of the process data of some I/O modules or their variations in the process image depends on the fieldbus coupler/-controller used. Please take this information as well as the particular design of the respective control/status bytes from the section "Fieldbus Specific Design of the Process Data" included in the description concerning the process image of the corresponding coupler/controller.

---

### 2.1.1.7.1 Standard Data Format

For the standard module 750-466 and the variations 750-466/001 the input current ranging from 4 mA to 20 mA is scaled on the numerical values ranging from 0x0000 to 0x7FF9.

Process values of module 750-466, 750-466/000-001						
Input current 4 mA - 20 mA	numerical value			Status- byte hex.	LED Error AI 1, 2	
	binary Measured value	*) X F Ü	hex. dec.			
<0	not possible (Reverse voltage protection)					
<4 - Δ**)	'0000.0000.0000.0	'011'	0x0003	3	0x41	on
<4	'0000.0000.0000.0	'000'	0x0000	0	0x00	off
4	'0000.0000.0000.0	'000'	0x0000	0	0x00	off
6	'0001.0000.0000.0	'000'	0x1000	4096	0x00	off
8	'0010.0000.0000.0	'000'	0x2000	8192	0x00	off
10	'0011.0000.0000.0	'000'	0x3000	12288	0x00	off
12	'0100.0000.0000.0	'000'	0x4000	16384	0x00	off
14	'0101.0000.0000.0	'000'	0x5000	20480	0x00	off
16	'0110.0000.0000.0	'000'	0x6000	24576	0x00	off
18	'0111.0000.0000.0	'000'	0x7000	28672	0x00	off
20	'0111.1111.1111.1	'000'	0x7FF8	32760	0x00	off
>20	'0111.1111.1111.1	'001'	0x7FF9	32761	0x42	off
>20 + Δ**)	'0111.1111.1111.1	'001'	0x7FF9	32761	0x42	on

\*) status bits: X = not used, F = short-circuit, Ü = oversize

\*\*\*) Δ = 0,1 ... 2,0 mA

### 2.1.1.7.2 Special Data Format

To digitalize the measurement value, the variation 750-466/000-002 uses another resolution as the standard module.

For this variation, the input current ranging from 4 mA to 20 mA is scaled on the numerical values ranging from 0x0000 to 0x0F99.

Process values of module 750-466/000-002						
Input current 4 mA - 20 mA	numerical value			Status- byte hex.	LED Error AI 1, 2	
	binary Measured value	* <sup>)</sup> X F Ü	hex. dec.			
<0	not possible (Reverse voltage protection)					
<4 - Δ <sup>**)</sup>	'0000.0000.0000.0	011'	0x0003 3	0x41	on	
<4	'0000.0000.0000.0	000'	0x0000 0	0x00	off	
4	'0000.0000.0000.0	000'	0x0000 0	0x00	off	
6	'0000.0001.1111.0	000'	0x01F0 500	0x00	off	
8	'0000.0011.1110.1	000'	0x03E8 1000	0x00	off	
10	'0000.0101.1101.1	000'	0x05D8 1500	0x00	off	
12	'0000.0111.1101.0	000'	0x07D0 2000	0x00	off	
14	'0000.1001.1100.0	000'	0x09C0 2500	0x00	off	
16	'0000.1011.1011.1	000'	0x0BB8 3000	0x00	off	
18	'0000.1101.1010.1	000'	0x0DA8 3500	0x00	off	
20	'0000.1111.1001.1	000'	0x0F98 3992	0x00	off	
>20	'0000.1111.1001.1	001'	0x0F99 3993	0x42	off	
>20 + Δ <sup>**)</sup>	'0000.1111.1001.1	001'	0x0F99 3993	0x42	on	

\*<sup>)</sup> status bits: X = not used, F = short-circuit, Ü = oversize

\*\*<sup>)</sup> Δ = 0,1 ... 2,0 mA

To digitalize the measurement value, the variation 750-466/000-200 uses a format adapted for the S5 control systems using FB 250.

For this variation, the input current ranging from 4 mA to 20 mA is scaled on the numerical values ranging from 0x1000 to 0x5000.

Process values of module 750-466/000-200						
Input current 4 mA - 20 mA	numerical value			Status- byte hex.	LED Error AI 1, 2	
	binary Measured value	*) X F Ü	hex.			dec.
<0	not possible (Reverse voltage protection)					
<4 - Δ**)	'0001.0000.0000.0	011'	0x1003	4099	0x41	on
<4	'0001.0000.0000.0	000'	0x1000	4096	0x00	off
4	'0001.0000.0000.0	000'	0x1000	4096	0x00	off
6	'0001.1000.0000.0	000'	0x1800	6144	0x00	off
8	'0010.0000.0000.0	000'	0x2000	8192	0x00	off
10	'0010.1000.0000.0	000'	0x2800	10240	0x00	off
12	'0011.0000.0000.0	000'	0x3000	12288	0x00	off
14	'0011.1000.0000.0	000'	0x3800	14336	0x00	off
16	'0100.0000.0000.0	000'	0x4000	16384	0x00	off
18	'0100.1000.0000.0	000'	0x4800	18432	0x00	off
20	'0101.0000.0000.0	000'	0x5000	20480	0x00	off
>20	'0101.0000.0000.0	001'	0x5001	20481	0x42	off
>20 + Δ**)	'0101.0000.0000.0	001'	0x5001	20481	0x42	on

\*) status bits: X = not used, F = short-circuit, Ü = oversize

\*\* ) Δ = 0,1 ... 2,0 mA





WAGO Kontakttechnik GmbH & Co. KG  
Postfach 2880 • D-32385 Minden  
Hansastraße 27 • D-32423 Minden  
Phone: 05 71/8 87 – 0  
Fax: 05 71/8 87 – 1 69  
E-Mail: [info@wago.com](mailto:info@wago.com)

Internet: <http://www.wago.com>

---